

SECONDARY SPECTRUM ACCESS NETWORKS

Recent Developments on the Spatial Models

The radio spectrum is a precious resource that underpins various wireless services. It is traditionally regulated by a fixed frequency assignment policy, which allocates frequency bands to license holders for exclusive use. Such a static and rigid

spectrum-licensing policy eliminates interference among different radio systems in a brutal-force way but results in very inefficient spectrum utilization [1]. Dynamic spectrum access (DSA) [2], [3] has been proposed as a promising approach to improve spectrum utilization

Xuemin Hong,
Cheng-Xiang Wang,
Hsiao-Hwa Chen,
and Yan Zhang

Digital Object Identifier 10.1109/MVT.2009.932543



by allowing new wireless systems to dynamically access or share the licensed band on a negotiated or an opportunistic basis.

DSA strategies can be broadly categorized into three models [3]: dynamic exclusive use model, open sharing model, and hierarchical access model. The first model maintains a rigid license-based policy but introduces more flexibility to allow license holders to lease or trade their spectrum freely by means of spectrum property rights or dynamic spectrum allocation. The open sharing model, also referred to as spectrum commons, embraces an unlicensed philosophy and allows peer users to have equal spectrum access rights and use a common spectrum without interfering the others. The third model adopts a hierarchical access structure with primary and secondary users. It allows the secondary users to access the licensed spectrum under the condition that no harmful interference is caused to the primary users (licensees). In recent years, the hierarchical access model has attracted great research interests because of its potential of significantly improving the spectrum utilization with minimum changes to the incumbents. In this article, we focus on secondary spectrum access networks based on the hierarchical access model.

The first fundamental task to design a secondary network is to ensure its coexistence with the primary network, i.e., the secondary network should control its interference to the primary network so that the quality-of-service (QoS) of the primary network is not significantly degraded. To this end, three approaches, namely, underlay, interweave, and overlay, have been proposed as the basis for designing secondary networks [4]. The underlay approach protects the primary services by enforcing a spectral mask on the transmission power of the secondary users, so that the power of secondary signals lies below the noise floor of the primary receivers. The interweave method exploits the temporal or geographical dynamics of the primary signal occupation and collects the temporary or local frequency voids, referred to as spectrum holes or white spaces [2], [5], [6] for the opportunistic use of secondary networks. The overlay scheme adopts the interference temperature concept [1], [2], [5] and keeps the signal-to-interference-and-noise-ratio (SINR) requirements fulfilled at the primary receivers.

Hierarchical spectrum access inevitably leads to complex interference scenarios where secondary signals seek to coexist with primary signals in temporal, frequency, or spatial domains. Before we can design a secondary system that fully exploits spectrum opportunities in all the above-mentioned three domains, it is a necessary step to first simplify the scenario and study the coexisting problem in each domain. In this context, spatial modeling concerns about the geographical occupations of the primary and secondary signals by considering the

HIERARCHICAL SPECTRUM ACCESS INEVITABLY LEADS TO COMPLEX INTERFERENCE SCENARIOS WHERE SECONDARY SIGNALS SEEK TO COEXIST WITH PRIMARY SIGNALS IN TEMPORAL, FREQUENCY, OR SPATIAL DOMAINS.

following three factors: the spatial distribution of the primary and secondary nodes, the transmission behavior, and the radio propagation effects. Since spatial modeling takes topology information into account, it is essential to characterize the relationship between large-scale secondary and primary networks and make reasonable predictions of the system-level performance.

In this article, we present some of the recent developments on spatial modeling for all the three types of secondary networks. For underlay and interweave systems, we review some existing spatial models and discuss the insights revealed by these models and the implications to system design. For the overlay system, a new spatial model is proposed, based on which an overlay network in the TV band is presented and its performance is tested by simulations.

Underlay System

Underlay secondary systems operate below the noise floor of the primary users. The underlay secondary transmission power spectrum density (PSD) is severely constrained by a spectral mask so that secondary signals appear to the primary receivers as background noise. Even with a very low PSD, an underlay secondary signal still contributes slightly to the rise of the noise floor. At the network level, the powers of multiple secondary signals accumulate at the primary receivers, and the aggregate interference can become disruptive. Therefore, modeling the aggregate interference at the network level is essential for designing the unharmed underlay secondary systems.

Aggregate Interference Model

Interference modeling considering a Poisson distribution of interferers has been well investigated and can be directly applied to model the interference raised by underlay secondary networks [7], [8]. A classic model assumes an ideal secondary network with an infinite number of secondary transmitters. The locations of secondary transmitters follow a Poisson point process with a density parameter λ_a , which denotes the average number of secondary terminals per unit area. We assume that the probability of a secondary transmitter being active is ρ . It follows that the locations of transmitting terminals also form a Poisson process with a density parameter $\lambda = \rho\lambda_a$. Moreover, it is assumed that all the active secondary terminals transmit with an identical power P according to the spectral mask. The secondary signals propagate

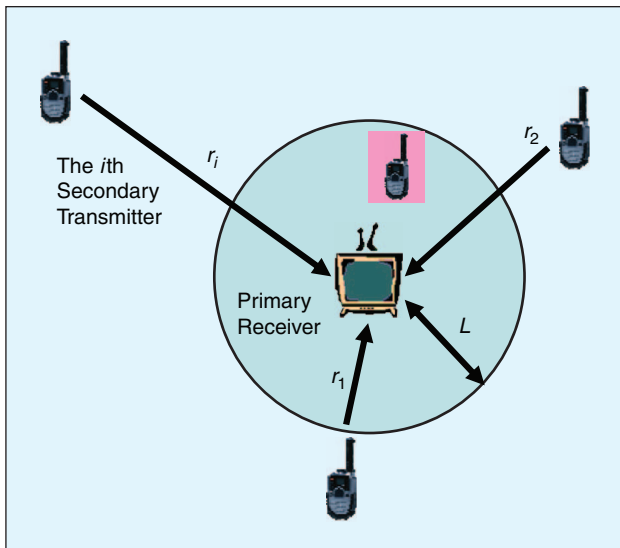

FIGURE 1 Aggregate interference model: secondary transmitters distributed in a Poisson field and a primary receiver with an exclusive region of radius L .

through the wireless channels subject to path loss, shadowing, and fast fading and reach the primary receiver as interference. It has been found that the probability density function (PDF) of the aggregate interference falls into the family of heavy-tailed α -stable distributions [8], which is undesirable since it suggests a higher possibility of disruptive interference.

Recently, a modified interference model based on the concept of exclusive region was studied in [7] and [8]. As illustrated in Figure 1, an exclusive region is defined as a circular disk centered at a primary receiver with a radius L . Any secondary terminal within the exclusive region is regarded as a harmful interferer and is forbidden to transmit. The PDF of the aggregate interference using the

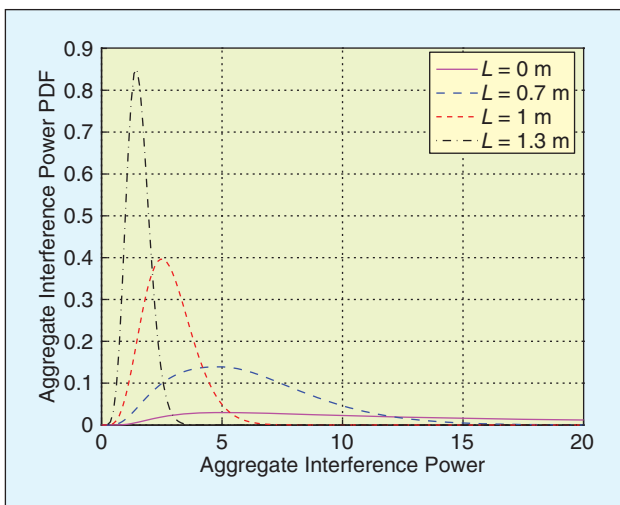

FIGURE 2 PDFs of the aggregate interference power with different values of the interference region radius L (secondary transmitter density $\lambda=1$).

modified interference model was first investigated in [7], considering only the path loss effects and further studied in [8] where path loss, shadowing, and fast fading effects were all taken into account.

Considering only the path loss effects, Figure 2 shows the PDFs of the aggregate interference power with $\lambda = 1$ and different values of the exclusive region radius L . When L is sufficiently large, it is found that the interference at a primary receiver can be approximated by a confined Gaussian-like distribution, a much more desirable distribution for secondary spectrum access systems compared with a heavy-tailed α -stable distribution. Figure 2 provides an insight that the disruptive aggregate interference is mainly caused by a small number of dominant interferers nearby the victim receiver. Once these dominant interferers are eliminated using an exclusive region, the aggregate interference power can be reduced significantly. It should be noted that, given certain constraints on the aggregate interference power, eliminating a few dominant secondary interferers within the exclusive region can allow more secondary users outside the exclusive region to transmit. In other words, the overall secondary traffic may increase if no secondary transmission is allowed within the exclusive region.

Cognitive Ultrawideband System

The most prominent example of an underlay secondary system is ultrawideband (UWB). In 2002, the Federal Communications Commission (FCC) authorized the unlicensed use of UWB in 3.1–10.6 GHz with a limit on the transmit PSD of 241.3 dBm/MHz [9]. Despite such a severe limit, there has been a serious concern on the possibility that UWB emissions can interfere with many other existing services operating between 3.1 and 10.6 GHz, especially in the presence of dense UWB transmitters.

The recently proposed cognitive UWB systems [9] provide a promising solution to implement the concept of exclusive region and thereby reducing UWB interference to other systems. By sensing the radio environment, a cognitive UWB device can detect or predict the presence of the primary receivers using the following three methods. The first approach is to sense the signals emitted by the RF front end of the primary receivers due to local oscillator leakage [10]. This approach requires no modification to the primary receivers but is limited to short-distance detection. The second approach is to modify the primary receivers to transmit beacon signals [2]. The drawback is that some modifications of the primary receivers become necessary. The previous two approaches seek to detect the primary receivers directly, whereas the third approach is to sense primary transmitters and predict the presence of the primary receivers to be inside the service areas around the detected

primary transmitters. This approach is less accurate but relatively easy to implement.

Interweave System

The interweave approach is based on the idea of opportunistic spectrum access that exploits white spaces, defined as the frequency voids unoccupied by the primary signals. Essentially, the interweave secondary networks coexist with the primary networks by operating in orthogonal signal spaces. Given the frequency band of interest, white spaces exist in both temporal and spatial domains. The temporal white spaces refer to the idle periods between bursty transmissions of the primary systems, whereas the spatial white spaces refer to the areas where no significant primary signal can be detected.

Exploiting the spatial white spaces has attracted great interest in recent years. A well-known example of the spatial white spaces is in TV bands where multiple TV channels are interleaved to avoid self-interference so that a single channel is only used sparsely in disjoint regions. Characterization and modeling of spatial white spaces are of great importance for the planning and design of interweave secondary systems. In what follows, we will present a theoretical spatial model recently proposed in [11] that captures the spatial characteristics of white spaces in the presence of a large-scale random primary network.

Spatial Model for White Spaces

The spatial model considers a random primary network on a plane operating on a specific frequency band. The locations of potential primary transmitters are modeled as a stationary Poisson point process Φ of density γ . To avoid or mitigate self-interference inside the primary network, a subset of active transmitters is selected among all potential transmitters so that every two active transmitters are spatially separated with a minimum distance of d_{\min} . The locations of active transmitters can then be described by a Matern hard-core point process Φ_{th} [11] with a density parameter γ and a distance parameter d_{\min} .

It is further assumed that all the active primary terminals transmit with a constant power P . Based on the locally perceived primary signal power level, an area on the plane can be marked as a black space, gray space, or white space. Black spaces can be regarded as service areas with sufficiently high-power primary signals. Gray spaces are interference areas where primary signals are too weak to support primary services but are still significant sources of interference. As illustrated in Figure 3, by considering a deterministic propagation model (path loss model), the black space areas are given by disks of radius r around each primary transmitter, the gray space areas are given by the concentric disks of radius R ($R > r$) excluding the black space areas, and the white space areas are given by the rest of the plane.

THE SECONDARY TRANSMISSION POWER SPECTRUM DENSITY IS SEVERELY CONSTRAINED BY A SPECTRAL MASK SO THAT SECONDARY SIGNALS APPEAR TO THE PRIMARY RECEIVERS AS BACKGROUND NOISE.

The aforementioned spatial model is applied to calculate the area fraction of white spaces on the plane, i.e., the mean fraction of white spaces in a unit area. Given γ , R , and r , an upper bound of the white space area fraction is given by [11]

$$\chi^U = \exp\left\{-\frac{R^2}{R^2 + r^2} \{1 - \exp[-\gamma\pi(R+r)^2]\}\right\} \quad (1)$$

and a lower bound is given by [11]

$$\chi^L = 1 - \frac{R^2}{R^2 + r^2} \{1 - \exp[-\gamma\pi(R+r)^2]\}. \quad (2)$$

With $R/r = 2$, in Figure 4, we show the above bounds as functions of the primary node density γ with different values of r . From (1) and (2), we can see that when $\gamma \rightarrow \infty$, the upper and lower bounds converge to $\lim_{\gamma \rightarrow \infty} \chi^U = \exp[R^2/(R^2 + r^2)]$ and $\lim_{\gamma \rightarrow \infty} \chi^L = 1 - R^2/(R^2 + r^2)$, respectively [11]. When $R/r = 2$, we have $\lim_{\gamma \rightarrow \infty} \chi^U = 0.64$ and $\lim_{\gamma \rightarrow \infty} \chi^L = 0.56$. In other words, regardless of the primary user density γ , at least 56% of the plane will be detected as white space. This finding is somewhat surprising, since one would generally expect the white spaces to vanish when the primary transmitter density γ is sufficiently large. In [11], it was shown that even when R/r increases, the area fraction of

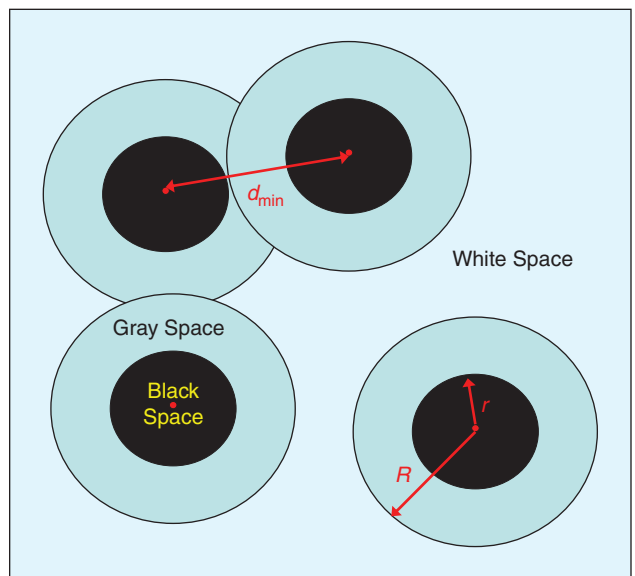

FIGURE 3 Spatial distribution of black spaces, gray spaces, and white spaces with randomly located primary transmitters.

THE TEMPORAL WHITE SPACES REFER TO THE IDLE PERIODS BETWEEN BURSTY TRANSMISSIONS OF THE PRIMARY SYSTEMS, WHEREAS THE SPATIAL WHITE SPACES REFER TO THE AREAS WHERE NO SIGNIFICANT PRIMARY SIGNAL CAN BE DETECTED.

white spaces will decrease slowly but remain significant for a practical value of R/r .

The above bounds on the white space area fraction mainly result from the following three modeling assumptions: 1) two active primary transmitters need to be separated by a minimum distance of $d_{\min} = R + r$; 2) the locations of active primary nodes are completely randomized; 3) all active primary nodes transmit with a constant power P . All these assumptions can be practical for some wireless networks: the spatial separation comes from self-interference constraints, the location randomness comes from the mobility of the nodes, and the constant power comes from the lack of effective power control schemes.

Opportunistic Cognitive Radio Network

Opportunistic cognitive radio network [5], [6] as an interweave secondary system has been proposed as a promising solution to exploit white spaces by means of spectrum sensing and adaptive transceiver reconfiguration. On the basis of the aforementioned spatial model, we will discuss some design guidelines of opportunistic cognitive radio networks here.

First, let us consider a scenario where an opportunistic cognitive radio network seeks to reuse the white spaces of a random primary network (e.g., Wi-Fi networks). From previous discussions, we have shown that the

white spaces are spatially fragmented and therefore difficult to be reused. If the cognitive radios have similar transmit characteristics as the primary ones, introducing cognitive radio users to share this band would be the same as increasing the number and density of the primary users. As shown previously, even when the primary user density γ tends to infinity, the spectrum utilization efficiency is still low. Therefore, to improve spectrum utilization beyond the bounds shown in (1) and (2), it is necessary for the cognitive radio network to differentiate its transmission behaviors from the primary system. From Figure 3, we can imagine that if the cognitive radio users are able to adjust their transmit powers and thereby adaptively fill in the fragmented white spaces, the overall spectrum utilization can be improved significantly. To decide a proper transmit power level, awareness of primary transmitter locations is essential for cognitive radio users. To this end, collaborative spectrum-sensing serves as a promising solution to allow cognitive radio devices to share the local sensing information and make robust predictions about the status of primary transmitters [6].

Let us consider another scenario where a random cognitive radio network is deployed to reuse a block of white spaces in a large area, e.g., the white spaces in the TV band. Clearly, low spectrum utilization is inevitable if the cognitive radio network is designed, similar to the random primary network mentioned earlier, with a minimum transmitter separation distance, random user location, and constant transmit power. Correspondingly, we can obtain three guidelines in designing a better cognitive radio network to exploit the block white spaces more effectively. First, it is desirable to abandon the minimum transmitter separation requirement, i.e., to allow the coverage of two cognitive radio transmitters to overlap. In practice, this can be achieved by interference cancellation or cooperative communication techniques. Second, it is beneficial to organize the locations of active cognitive radio transmitters to a structured topology. This can potentially be achieved by topology-aware medium access control (MAC) protocols. Third, as mentioned in the previous paragraph, adaptive power control can also significantly improve the white space utilization.

Overlay System

The idea behind overlay systems is that secondary transmissions are allowed as long as the SINR requirements at all the primary receivers are fulfilled. Unlike the underlay approach that controls interference with a predefined spectral mask or the interweave approach that senses and avoids primary signals, the overlay approach aims to control the interference experienced by the primary receivers. It describes a futuristic, long-term vision of the secondary spectrum access systems. So far, researches on overlay systems have mainly focused on theoretical

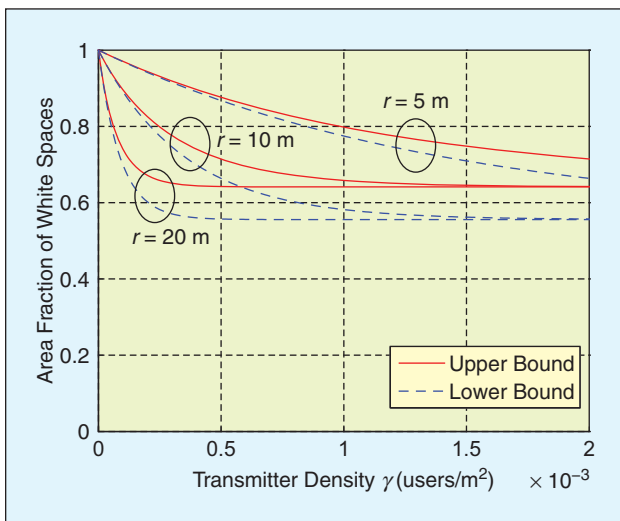

FIGURE 4 Upper and lower bounds of the white space area fraction as functions of transmitter density γ with different values of r ($R/r = 2$).

aspects. The purpose is to understand the system limits and long-term potentials. To this end, some pioneering information theoretic work on the channel capacity of overlay (cognitive) radio systems was presented in [4] and [12]. Recently, a system-level capacity study of a centralized overlay network was presented in [13].

The interference temperature was proposed by the FCC in 2002 [1] as a new metric to assess the interference at the primary receivers. Similar to the concept of noise temperature, interference temperature measures the power and bandwidth occupied by the interference. Moreover, the concept of interference temperature limit was introduced to characterize the worst case interfering scenario in a particular frequency band and at a particular geographic location. Secondary transmissions in a given band are considered to be harmful only if they would violate the interference temperature limit. Although the FCC has abandoned its use of interference temperature in 2007 because of current difficulties in implementing this concept, the philosophy behind it is still valid, and this concept is still widely used to facilitate the research of overlay systems.

The model that describes the interference-temperature limits is called interference temperature model (ITM), which can be presented in either the frequency or spatial domain. Although most of the work in the literature characterized the ITM in the frequency domain [14], a spatial description of the ITM is of equivalent importance. In what follows, a new spatial ITM will be proposed.

Spatial ITM

The proposed spatial ITM is shown in Figure 5. The primary system consists of multiple primary transmitters located along the x axis. Because of radio propagation, the powers of primary signals are spread heterogeneously over the space. For simplicity, we consider only the path loss effects, which are illustrated conceptually in Figure 5 using straight lines.

Now assume that a minimum SINR is required at a primary receiver to successfully recover the transmitted primary information. A service area can be defined around each primary transmitter to indicate the region where primary signals are strong and can be successfully recovered. Different methods should be used to specify the interference temperature limits within and outside the service areas. Within the service area, the interference temperature limit is specified to satisfy the minimum SINR requirement. More specifically, it is given by the local primary signal power (in dB) subtracting the required minimum SINR (in dB). In contrast, outside the primary service area, an interference temperature limit is specified to guarantee that an interfering signal with the highest allowable power, when propagating to the edges of the primary service areas, will have a power

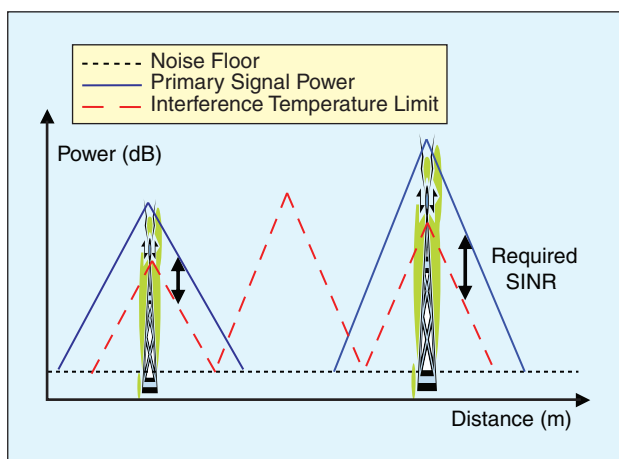

FIGURE 5 Spatial ITM in overlay systems.

lower than the noise floor. As we can see from Figure 5, a spatial ITM is featured by interference temperature limits with triangular shapes, making it much different from the spectral ITMs [14] where rectangular shapes are typical.

The aforementioned spatial ITM clearly shows the difference between the overlay and underlay or interweave systems. Compared with the underlay systems, an overlay system can dynamically adjust the transmit power. Compared with the interweave systems, an overlay system allows secondary transmissions not only in white spaces but also in black and gray spaces. Based on the aforementioned spatial ITM concept, a simple example of an overlay system in the TV bands is presented subsequently.

Overlay Secondary Network in the TV Band

TV broadcasting occupies frequency bands ranging from 54 to 862 MHz. Secondary use of TV bands has attracted great interest because of the well-known underutilization and desirable propagation properties in these bands. Currently, the IEEE 802.22 [15] standardization group is working to establish an interweave secondary system in the vacant TV bands. Here, we will present an overlay secondary network in the TV band. Compared with the IEEE 802.22 system, one of the major advantages of this overlay secondary network lies on its ability of operating in the black and gray spaces of TV signals.

We consider a scenario where the secondary and TV systems use the same frequency band and occupy the same geographical area. Both the systems receive interference from each other. The challenge to design an overlay network is twofold. First, the TV (primary) services should be protected. This can be achieved by interference temperature based power control, where a secondary user can sense the local TV signal power, calculate the interference temperature limit, and keep its transmit

CHARACTERIZATION AND MODELING OF SPATIAL WHITE SPACES ARE OF GREAT IMPORTANCE FOR THE PLANNING AND DESIGN OF INTERWEAVE SECONDARY SYSTEMS.

power under this limit. Second, the secondary receivers should be able to recover the transmitted secondary information in the presence of strong interfering TV signals. Given that the TV signals received by a secondary user are sufficiently strong and can be reliably recovered, the secondary receiver can apply the well-known successive interference cancellation techniques to first recover and cancel the TV signal from the received (mixed) signal, and then process the remaining signal to recover the transmitted secondary information.

A simple simulation model was built to illustrate the above-mentioned concept of overlay systems

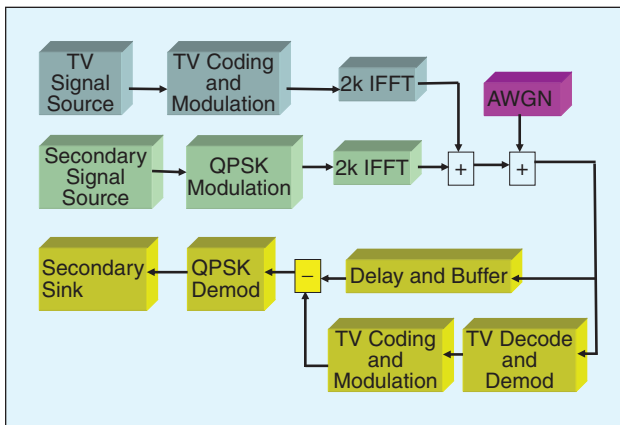

FIGURE 6 Block diagram of an overlay secondary system coexisting with a DVB-T system.

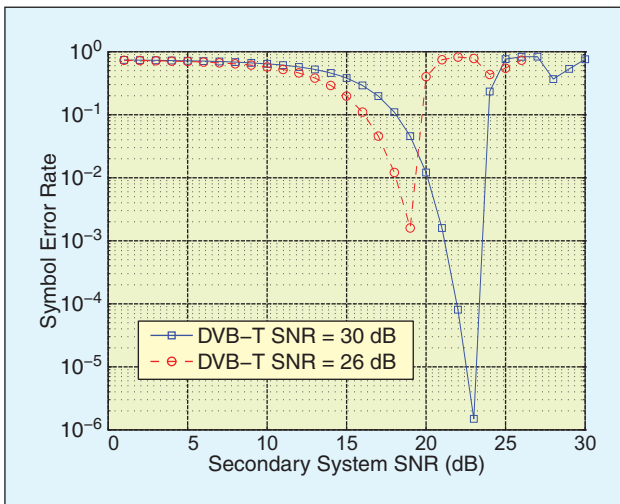

FIGURE 7 SER performance of an overlay secondary system in the presence of high-power interfering DVB-T signals.

operating in black spaces. The block diagram of the simulation model is shown in Figure 6. We assume concurrent, synchronized transmissions of a secondary signal and a terrestrial digital video broadcasting (DVB-T) signal in an 8-MHz DVB-T channel. The DVB-T signal is derived from a standard DVB-T transmitter using 16 quadrature amplitude modulation (QAM) and a channel coder of rate 2/3. On the other hand, the secondary signal is generated from a secondary transmitter that employs quadrature phase shift keying (QPSK) with a symbol rate of 6.75 million symbols per second. Both the secondary and DVB-T transmitters use 2,048 point orthogonal frequency division multiplexing (OFDM) modulation, after which the two signals are scaled, added, and mixed with the white Gaussian noise to represent the received signal at a secondary receiver. The power of the received secondary signals, DVB-T signals, and noise are denoted as P_s , P_w , and N_0 , respectively. The secondary receiver first tries to recover the DVB-T signal based on the known DVB-T transmission structure and then cancels or subtracts the recovered DVB-T signal from the received signal. The remaining signal is further processed to recover the secondary information.

Our goal is to evaluate the symbol error rate (SER) of the secondary communication link. The two important parameters that affect the secondary link performance are the secondary signal-to-noise ratio (SNR) $\rho_s = P_s/N_0$ and the primary SNR $\rho_w = P_w/N_0$. In Figure 7, the SERs are shown as a function of the secondary SNR conditioned on different values of the DVB-T (primary) SNR. When the secondary signal has relatively small power compared with the DVB-T signal, the DVB-T signal can be successfully recovered and canceled, so that the SER drops with the increasing secondary SNR. However, when the secondary signal power reaches a certain threshold, the recovery of DVB-T signals become erroneous and the resulting SER rises quickly.

Figure 7 suggests that power control at the secondary transmitters in an overlay system should guarantee that not only the primary receivers are protected from the interference but also the secondary receivers should be able to successfully recover the primary signal to perform subsequent recovery of the secondary information. Real-time interactions between the secondary transmitters and primary or secondary receivers are therefore desirable to perform such a task.

Conclusions

We have presented some recent developments on the spatial models of underlay, interweave, and overlay secondary networks. For underlay systems, we have studied the aggregate interference assuming a Poisson field of secondary interferers. The study has justified the

development of cognitive underlay systems with interference avoidance abilities. For interweave systems, we have reviewed a recently proposed spatial model and discussed the guidelines of designing opportunistic cognitive radio networks. For overlay systems, we have proposed a spatial ITM and an overlay secondary system that operates in TV bands. For all the three types of secondary networks, spatial modeling is shown to have great importance for system level design and evaluation of large-scale secondary networks.

Acknowledgment

Cheng-Xiang Wang acknowledges the support from the Scottish Funding Council for the Joint Research Institute in Signal and Image Processing with the University of Edinburgh, which is a part of the Edinburgh Research Partnership in Engineering and Mathematics.

Author Information

Xuemin Hong received his B.S. degree in communication engineering from Beijing Information Technology Institute, China, in 2004. He received his Ph.D. degree in wireless communications from Heriot-Watt University, United Kingdom, in 2008. He is currently a post-doc research fellow at the University of Waterloo, Canada. From 2004 to 2005, he was affiliated with King's College London, United Kingdom. He has published more than ten technical papers in major international journals and conferences and one book chapter in the area of wireless communications. His research interests include cognitive radio networks, wireless propagation channel modeling, multiple antenna technologies, and ultrawideband systems.

Cheng-Xiang Wang received his Ph.D. degree in wireless communications from Aalborg University, Aalborg, Denmark, in 2004. He has been a lecturer at Heriot-Watt University, Edinburgh, United Kingdom, since 2005. He is also an honorary fellow of the University of Edinburgh, United Kingdom, a guest researcher of Xidian University, China, and an adjunct professor of Guilin University of Electronic Technology, China. He was a research fellow at the University of Agder, Norway, from 2001 to 2005, a visiting researcher at Siemens AG-Mobile Phones, Germany, in 2004, and a research assistant at Technical University of Hamburg-Harburg, Germany, from 2000 to 2001. He has published one book chapter and more than 110 papers in refereed journals and conference proceedings in the area of mobile communications and networks. He serves as an editor for four international journals, including *IEEE Transactions on Wireless Communications*, and has served on the Technical Program Committee (chair/member) for more than 40 international conferences.

Hsiao-Hwa Chen received his B.Sc. and M.Sc. degrees from Zhejiang University, China, and a Ph.D. degree from the University of Oulu, Finland, in 1982, 1985, and 1991, respectively. He is currently a full professor in

the Department of Engineering Science, National Cheng Kung University, Taiwan. He has authored or coauthored more than 250 technical papers in major international journals and conferences, five books, and three book chapters in the areas of communications. He served as general chair, TPC chair, and symposium chair for many international conferences. He served or is serving as an editor and guest editor for numerous technical journals. He is the founding editor-in-chief of Wiley's *Security and Communication Networks Journal* (www.interscience.wiley.com/journal/security). He is the recipient of the Best Paper Award in IEEE WCNC 2008.

Yan Zhang received his Ph.D. degree from Nanyang Technological University, Singapore. Since August 2006, he has been working with Simula Research Laboratory, Norway. He is currently serving as the book series editor for *Wireless Networks and Mobile Communications* (Auerbach Publications, Taylor and Francis Group). He serves as a program cochair for BROADNETS 2009 and IWCMC 2009, symposium cochair for ChinaCom 2009 and ChinaCom 2008, industrial cochair for MobiHoc 2008, program cochair for UIC-08, program vice cochair for IEEE ISM 2007, and publication chair for IEEE ISWCS 2007. His research interests include resource, mobility, spectrum, and energy management in wireless networks.

References

- [1] Federal Communication Commission, "Spectrum policy task force report," Washington, DC, FCC 02-155, Nov. 2002.
- [2] I. F. Akyildiz, W. Y. Lee, M. C. Vuran, and S. Mohanty, "Next generation dynamic spectrum access/cognitive radio wireless networks: A survey," *Comput. Networks*, vol. 50, no. 13, pp. 2127–2159, Sept. 2006.
- [3] Q. Zhao and B. M. Sadler, "A survey of dynamic spectrum access," *IEEE Signal Process. Mag.*, vol. 24, no. 3, pp. 79–89, May 2007.
- [4] S. Srinivasa and S. A. Jafar, "The throughput potential of cognitive radio: A theoretical perspective," *IEEE Commun. Mag.*, vol. 45, no. 5, pp. 73–79, May 2007.
- [5] S. Haykin, "Cognitive radio: Brain-empowered wireless communications," *IEEE J. Selected Areas Commun.*, vol. 23, no. 2, pp. 201–220, Feb. 2005.
- [6] C.-X. Wang, H.-H. Chen, X. Hong, and M. Guizani, "Cognitive radio network management: Tuning in to real-time conditions," *IEEE Veh. Technol. Mag.*, vol. 3, no. 1, pp. 28–35, Mar. 2008.
- [7] R. Menon, R. M. Buehrer, and J. H. Reed, "Outage probability based comparison of underlay and overlay spectrum sharing techniques," in *Proc. IEEE DySPAN'05*, Baltimore, MD, USA, Nov. 2005, pp. 101–109.
- [8] X. Hong, C.-X. Wang, and J. Thompson, "Interference modeling of cognitive radio networks," in *Proc. IEEE VTC'08-Spring*, Singapore, May 2008, pp. 1851–1855.
- [9] W. Q. Malik and D. J. Edwards, "Cognitive techniques for ultrawideband communications," in *Proc. IET Seminar on Ultra Wideband Systems, Technologies and Applications*, London, U.K., Apr. 2006, pp. 81–86.
- [10] B. Wild and K. Ramchandran, "Detecting primary receivers for cognitive radio applications," in *Proc. IEEE DySPAN'05*, Baltimore, USA, Nov. 2005, pp. 124–130.
- [11] X. Hong, C.-X. Wang, J. Thompson, and Y. Zhang, "Demystifying white spaces," in *Proc. IEEE ICCAS'08*, Xiamen, China, May 2008, pp. 350–354.
- [12] N. Devroye, P. Mitran, and V. Tarokh, "Limits on communications in a cognitive radio channel," *IEEE Commun. Mag.*, vol. 44, no. 6, pp. 44–49, June 2006.
- [13] X. Hong, C.-X. Wang, and J. S. Thompson, "Uplink cell capacity of cognitive radio networks under interference outage constraints," in *Proc. IEEE ICCAS'08*, Xiamen, China, May 2008, pp. 333–338.
- [14] T. C. Clancy, "Formalizing the interference temperature model," *Wireless Commun. Mobile Computing*, vol. 7, no. 9, pp. 1077–1086, Sept. 2007.
- [15] C. Cordeiro, K. Challapali, D. Birru, and S. Shankar, "IEEE 802.22: The first worldwide wireless standard based on cognitive radios," in *Proc. IEEE DySPAN'05*, Maryland, USA, pp. 328–337. **VT**